

Rotec Overschuif Flenzen

passend op PVC kraagbus

Drilling Standard: EN1092 PN10



#	DN (mm)	Pmax (bar)	Pipe OD (mm)	D (mm)	d1 (mm)	d10 (mm)	r1 (mm)	k (mm)	Holes (no.)	d2 (mm)	b1 (mm)	Article Number
1	10	16	16	98	23	22	3	60	4	14	12	BRPVC-10-23-16/16
2	15	16	20	98	28	27	3	65	4	14	14	BRPVC-15-28-16/16
3	20	16	25	116	34	33	3	75	4	14	15	BRPVC-20-34-16/16
4	25	16	32	116	42	40	3	85	4	14	16	BRPVC-25-42-16/16
5	32	16	40	140	51	50	3	100	4	18	16	BRPVC-32-51-16/16
6	40	16	50	154	62	61	3	110	4	18	18	BRPVC-40-62-16/16
7	50	16	63	164	78	75	4	125	4	18	18	BRPVC-50-78-16/16
8	65	10	75	184	92	89	4	145	4	18	16	BRPVC-65-92-10/16
9	65	16	75	184	92	89	4	145	4	18	22	BRPVC-65-92-16/16
10	80	6	90	200	112	108	4	160	8	18	18	BRPVC-80-112-06/16
11	80	10	90	200	112	108	4	160	8	18	23	BRPVC-80-112-10/16
12	80	16	90	200	112	108	4	160	8	18	28	BRPVC-80-112-16/16
13	100	6	110	228	134	132	5	180	8	18	18	BRPVC-100-134-06/16
14	100	10	110	228	134	132	5	180	8	18	25	BRPVC-100-134-10/16
15	100	16	110	228	134	132	5	180	8	18	30	BRPVC-100-134-16/16
16	125	6	140	254	167	163	5	210	8	18	20	BRPVC-125-167-06/16

Disclaimer

Whilst every care is taken to ensure that the information on this website is complete and accurate, the Rotec Composite Group BV cannot accept responsibility for any omissions or inaccuracies or for any consequences arising therefrom. By using this website, the user accepts the terms of this disclaimer.

25-01-2024

Rotec Overschuif Flenzen

passend op PVC kraagbus

Drilling Standard: EN1092 PN10



#	DN (mm)	Pmax (bar)	Pipe OD (mm)	D (mm)	d1 (mm)	d10 (mm)	r1 (mm)	k (mm)	Holes (no.)	d2 (mm)	b1 (mm)	Article Number
17	125	10	140	254	167	163	5	210	8	18	26	BRPVC-125-167-10/16
18	125	16	140	254	167	163	5	210	8	18	33	BRPVC-125-167-16/16
19	150	6	160	284	189	185	5	240	8	22	22	BRPVC-150-189-06/16
20	150	10	160	284	189	185	5	240	8	22	30	BRPVC-150-189-10/16
21	150	16	160	284	189	185	5	240	8	22	38	BRPVC-150-189-16/16
22	200	4	175	342	226	222	6	295	8	22	25	BRPVC-200-226-04/10
23	200	4	200	342	235	232	6	295	8	22	25	BRPVC-200-235-04/10
24	200	4	225	342	252	248	6	295	8	22	25	BRPVC-200-252-04/10
25	200	10	175	342	226	222	6	295	8	22	38	BRPVC-200-226-10/10
26	200	10	200	342	235	232	6	295	8	22	38	BRPVC-200-235-10/10
27	200	10	225	342	252	248	6	295	8	22	38	BRPVC-200-252-10/10
28	250	4	250	405	277	273	6	350	12	22	28	BRPVC-250-277-04/10
29	250	4	280	405	310	306	6	350	12	22	28	BRPVC-250-310-04/10
30	250	10	250	405	277	273	6	350	12	22	42	BRPVC-250-277-10/10
31	250	10	280	405	310	306	6	350	12	22	42	BRPVC-250-310-10/10
32	300	4	315	458	348	344	6	400	12	22	32	BRPVC-300-348-04/10
33	300	10	315	458	348	344	6	400	12	22	46	BRPVC-300-348-10/10

Disclaimer

Whilst every care is taken to ensure that the information on this website is complete and accurate, the Rotec Composite Group BV cannot accept responsibility for any omissions or inaccuracies or for any consequences arising therefrom. By using this website, the user accepts the terms of this disclaimer.

Rotec Overschuif Flenzen

passend op PVC kraagbus

Drilling Standard: EN1092 PN10

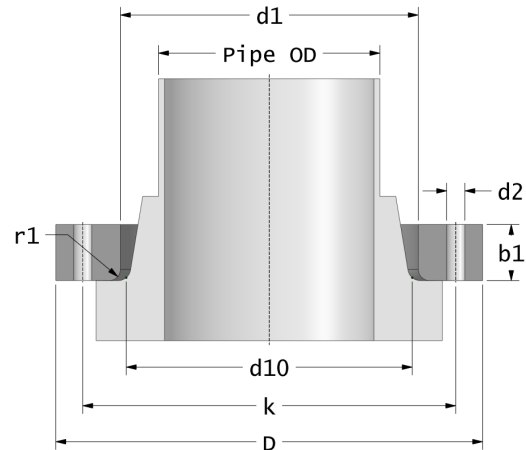

#	DN (mm)	Pmax (bar)	Pipe OD (mm)	D (mm)	d1 (mm)	d10 (mm)	r1 (mm)	k (mm)	Holes (no.)	d2 (mm)	b1 (mm)	Article Number
34	350	4	355	510	388	384	6	460	16	22	30	BRPVC-350-388-04/10
35	350	10	355	510	388	384	6	460	16	22	42	BRPVC-350-388-10/10
36	400	4	400	570	442	438	6	515	16	26	32	BRPVC-400-442-04/10
37	400	10	400	570	442	438	6	515	16	26	44	BRPVC-400-442-10/10

Disclaimer

Whilst every care is taken to ensure that the information on this website is complete and accurate, the Rotec Composite Group BV cannot accept responsibility for any omissions or inaccuracies or for any consequences arising therefrom. By using this website, the user accepts the terms of this disclaimer.

25-01-2024