

Rotec Stub Flanges (SFP for Dual Laminate Pipes)

Drilling Standard: EN1092 PN16

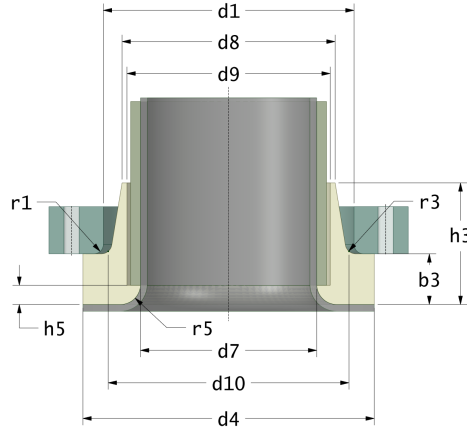
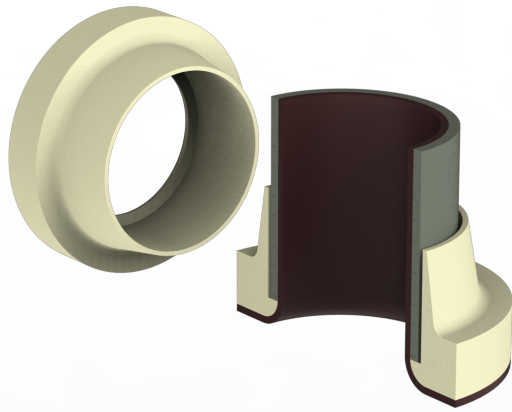

#	DN (mm)	Pmax (bar)	d4 (mm)	d7 (mm)	d9 (mm)	d8 (mm)	d1 (mm)	d10 (mm)	r1 (mm)	r3 (mm)	h5 (mm)	r5 (mm)	h3 (mm)	b3 (mm)	Article Number
1	25	16	68	32	38	44	51	50	3	2	4	3	30	12	SFP-25-32-68-16
2	32	16	78	40	46	50	55	54	3	3	4	3	32	14	SFP-32-40-78-16
3	40	16	88	50	56	62	69	68	3	3	4	3	35	14	SFP-40-50-88-16
4	50	16	102	63	69	76	83	82	3	3	6	4	40	14	SFP-50-63-102-16
5	65	16	122	75	81	88	96	95	4	3	6	4	50	18	SFP-65-75-122-16
6	80	16	138	90	96	105	112	111	4	3	6	4	55	23	SFP-80-90-138-16
7	100	16	158	110	116	126	134	133	5	4	8	4	62	25	SFP-100-110-158-16
8	125	10	188	125	134	144	161	160	5	4	8	4	64	20	SFP-125-125-188-10
9	150	10	212	160	166	180	189	188	5	4	8	4	71	22	SFP-151-160-212-10
10	150	16	212	160	167	180	189	188	5	4	8	4	81	32	SFP-151-160-212-16
11	200	10	268	200	206	220	238	237	6	5	8	4	89	29	SFP-201-200-268-10
12	200	16	268	200	208	220	238	237	6	5	8	4	95	35	SFP-201-200-268-16
13	250	6	320	250	256	271	294	293	6	5	8	4	101	28	SFP-251-250-320-06
14	300	6	376	300	306	326	344	343	6	5	8	4	116	30	SFP-301-300-376-06
15	300	10	376	300	308	326	344	343	6	5	8	4	126	40	SFP-301-300-376-10

Disclaimer

Whilst every care is taken to ensure that the information on this website is complete and accurate, the Rotec Composite Group BV cannot accept responsibility for any omissions or inaccuracies or for any consequences arising therefrom. By using this website, the user accepts the terms of this disclaimer.