

Rotec Bunde (SFP für GFK-Rohre)

Drilling Standard: EN1092 PN16

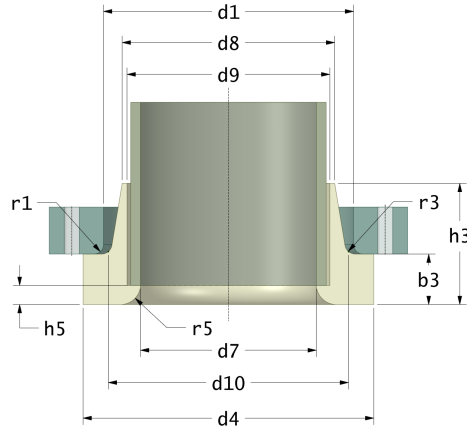
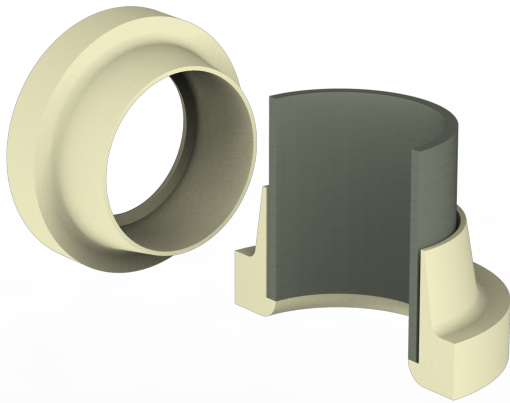

#	DN (mm)	Pmax (bar)	d4 (mm)	d7 (mm)	d9 (mm)	d8 (mm)	d1 (mm)	d10 (mm)	r1 (mm)	r3 (mm)	h5 (mm)	r5 (mm)	h3 (mm)	b3 (mm)	Article Number
1	25	16	68	25	31	39	51	50	3	2	4	2	30	12	SFP-25-25-68-16
2	32	16	78	32	38	50	59	58	3	3	4	3	32	14	SFP-32-32-78-16
3	40	16	88	40	46	55	69	68	3	3	4	3	35	14	SFP-40-40-88-16
4	50	16	102	50	57	66	83	82	4	3	6	3	40	14	SFP-50-50-102-16
5	65	16	122	65	73	83	96	95	4	3	6	4	50	18	SFP-65-65-122-16
6	80	10	138	80	87	96	112	111	4	3	6	4	48	16	SFP-80-80-138-10
7	80	16	138	80	89	96	112	111	4	3	6	4	55	23	SFP-80-80-138-16
8	100	10	158	100	108	120	134	133	5	4	8	4	55	18	SFP-100-100-158-10
9	100	16	158	100	111	120	134	133	5	4	8	4	62	25	SFP-100-100-158-16
10	125	10	188	125	131	144	161	160	5	4	8	4	64	20	SFP-126-125-188-10
11	125	16	188	125	138	144	161	160	5	4	8	4	72	28	SFP-125-125-188-16
12	125	16	188	125	131	144	161	160	5	4	8	4	72	28	SFP-126-125-188-16
13	150	10	212	150	160	170	189	188	5	4	8	4	71	22	SFP-150-150-212-10
14	150	10	212	160	171	180	189	188	5	4	8	4	71	22	SFP-150-160-212-10
15	150	16	212	150	165	180	189	188	5	4	8	4	81	32	SFP-150-150-212-16
16	150	16	212	160	171	180	189	188	5	4	8	4	71	22	SFP-150-160-212-16
17	200	6	268	200	209	220	238	237	6	5	8	4	85	25	SFP-200-200-268-06
18	200	10	268	212	222	230	238	237	6	5	8	4	89	29	SFP-200-212-268-10
19	200	10	268	200	213	220	238	237	6	5	8	4	89	29	SFP-200-200-268-10

Disclaimer

Whilst every care is taken to ensure that the information on this website is complete and accurate, the Rotec Composite Group BV cannot accept responsibility for any omissions or inaccuracies or for any consequences arising therefrom. By using this website, the user accepts the terms of this disclaimer.

Rotec Bunde (SFP für GFK-Rohre)

Drilling Standard: EN1092 PN16

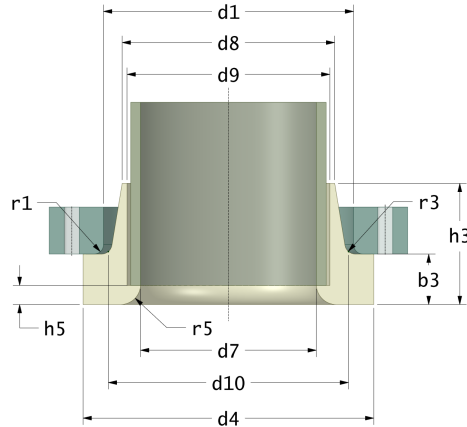
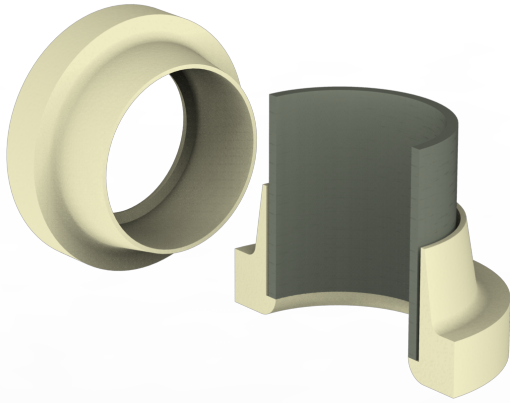

#	DN (mm)	Pmax (bar)	d4 (mm)	d7 (mm)	d9 (mm)	d8 (mm)	d1 (mm)	d10 (mm)	r1 (mm)	r3 (mm)	h5 (mm)	r5 (mm)	h3 (mm)	b3 (mm)	Article Number
20	200	16	268	212	222	230	238	237	6	5	8	4	95	35	SFP-200-212-268-16
21	250	6	320	250	260	271	294	293	6	5	8	4	101	28	SFP-250-250-320-06
22	250	10	320	250	257	271	294	293	6	5	8	4	111	38	SFP-250-250-320-10
23	250	10	320	252	262	271	294	293	6	5	8	4	111	38	SFP-250-252-320-10
24	250	10	320	250	265	282	294	293	6	5	8	4	111	38	SFP-252-250-320-10
25	300	6	376	300	312	326	344	343	6	5	8	4	116	30	SFP-300-300-376-06
26	300	10	376	300	318	326	344	343	6	5	8	4	126	40	SFP-300-300-376-10
27	300	10	376	313	326	338	348	347	6	5	8	4	126	40	SFP-300-313-376-10

Disclaimer

Whilst every care is taken to ensure that the information on this website is complete and accurate, the Rotec Composite Group BV cannot accept responsibility for any omissions or inaccuracies or for any consequences arising therefrom. By using this website, the user accepts the terms of this disclaimer.

27-06-2024